

Dialog 4224 Operator

Operator Terminal for MX-ONE™ Telephony System and MD110

User Guide



AASTRA

EN/LZT 103 63 R4A

© Aastra Telecom Sweden AB 2008. All rights reserved.

Dialog 4224 Operator

Table of Contents

Welcome	4
Important User Information	6
Description	8
Preparing the terminal	19
Incoming Calls	30
Extending	36
Service Features	47
Assistance	60
Outgoing Calls	74
Other Useful Features	83
Accessories	88
Installation	90
Troubleshooting	95
Glossary	96
Index	97

Welcome

Welcome to the user guide for the *Aastra Dialog 4224 Operator*. This guide describes the available features of the telephone when it is connected to **Aastra MX-ONE™ Telephony System** and **Aastra MD110**.

The functions and features available with this telephone are designed for easy use in all different telephone handling situations.

Depending on the version and configuration of the exchange that your telephone is connected to, some of the functions and features that are described in this user guide may not be available. There may also be some differences in the way your telephone is programmed. Please consult your system administrator if you need further information.

Some markets use differing codes for some features. In this guide they are described using the most common code.

The latest version of the user guide can be downloaded from:
<http://www.aastra.com>

Note: *Dialog 4224 Operator is a system terminal, i.e. it can only be used for an Aastra private branch exchange that supports this type of phone.*

Copyright

All rights reserved. No parts of this publication may be reproduced, stored in retrieval systems, or transmitted in any form or by any means, electronic, mechanical, photocopying, recording or otherwise, without prior written permission of the publisher except in accordance with the following terms.

When this publication is made available on Aastra media, Aastra gives its consent to downloading and printing copies of the content provided in this file only for private use and not for redistribution. No parts of this publication may be subject to alteration, modification or commercial use. Aastra will not be liable for any damages arising from use of an illegal modified or altered publication.

Aastra is a registered trademark of Aastra Technologies Limited. All other trademarks mentioned herein are the property of their respective owners.

Warranty

AASTRA MAKES NO WARRANTY OF ANY KIND WITH REGARD TO THIS MATERIAL, INCLUDING, BUT NOT LIMITED TO, THE IMPLIED WARRANTIES OF MERCHANTABILITY AND FITNESS FOR A PARTICULAR PURPOSE. Aastra shall not be liable for errors contained herein nor for incidental or consequential damages in connection with the furnishing, performance or use of this material.

Declaration of conformity

Hereby, Aastra Telecom Sweden AB, SE-126 37 Hågersten, declares that this terminal, is in conformity with the essential requirements and other relevant provisions of the European R&TTE directive 1999/5/EC.

Details to be found at: <http://www.aastra.com/sdoc>.



Important User Information

Safety instructions

Save these instructions.



Read these safety instructions before use!

Note: *When using your telephone or connected equipment, the following basic safety precautions should always be followed to reduce risk of fire, electrical shock and other personal injury.*

- Follow instructions in the equipment's user guide or other documentation.
- Always install equipment in a location and environment for which it is designed.
- For mains powered telephones: Only operate with the mains power voltage indicated. If you are uncertain of the type of power supplied to the building, consult property management or your local power company.
- For mains powered telephones: Avoid placing the telephone's power cable where it can be exposed to mechanical pressure as this may damage the cable. If the power supply cord or plug is damaged, disconnect the product and contact qualified service personnel.
- Headsets used with this equipment must comply with EN/IEC 60950-1 and for Australia AS/NZS 60950:2000.
- Do not make any changes or modifications to equipment without seeking approval from the party responsible for compliance. Unauthorized changes or modifications could void the user's authority to operate the equipment.
- Do not use the telephone to report a gas leak in the vicinity of the leak.
- Do not spill liquid of any kind on the product or use the equipment near water, for example, near a bathtub, washbowl, and kitchen sink, in a wet basement or near a swimming pool.
- Do not insert any object into equipment slots that is not part of the product or auxiliary product.
- Do not disassemble the product. Contact a qualified service agency when service or repair work is required.
- Do not use a telephone (other than cordless type) during an electrical storm.

Disposal of the product



Your product should not be placed in municipal waste. Please check local regulations for disposal of electronic products.

How this User Guide works

The initial section of the User Guide introduces the equipment and familiarises you with the layout of the Dialog 4224 Operator.

The main body of the User Guide covers all the operating functions e.g. answering and extending calls.

The conventions used within this section are:

Actions appear in an alternative **bold typeface** and the key diagram appears in the left hand margin opposite the text.

For example:



**Automatic
answer**

Press.

The systems response is shown with explanatory text and, if relevant, a display picture.

Description

The terminal

The Dialog 4224 Operator uses a combination of advanced digital technology, ISDN communication principles and distributed stored program control.

This makes it the perfect choice for an organisation that knows the value of fast and precise information handling.

The terminal consists of two components:

- Display unit which displays call information using alphanumeric characters.
- Handset or headset (headset is optional).

The handset is equipped with hearing aid function as standard.

Dialog 4224 Operator

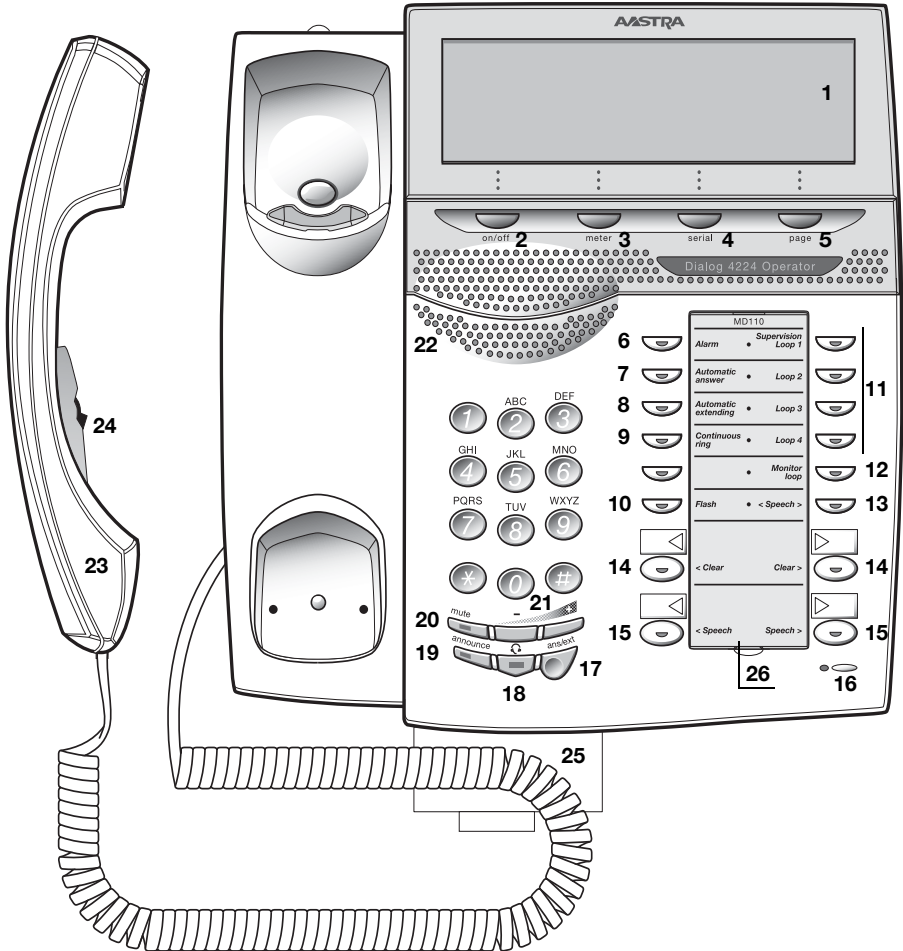

- 1 Display**
5x40 characters. See section [“Display information”](#) on page 14.
- 2 On/Off**
Switches the operator terminal on or off. Also used to deny more calls to the terminal. See section [“On/Off duty”](#) on page 19.

Note: If all operator terminals are in OFF state the exchange will be switched for Night Service.
- 3 Meter**
To mark an outgoing external line call for metering. See section [“Recall from a metered call”](#) on page 55.
- 4 Serial**
Used when an external caller wants to talk to several people in sequence. The call is automatically recalled to the terminal when the internal party goes on hook. See section [“Serial calls”](#) on page 56.
- 5 Page**
To access the paging capabilities. See sections [“Paging unit”](#) on page 44 and [“To paging unit”](#) on page 80.
- 6 Alarm**
To acknowledge any system alarms. Key lamp flashes slowly at alarms and shows steady light when the alarm is acknowledged. See section [“Alarm”](#) on page 85.
- 7 Automatic answer**
Automatic answer mode. Calls are automatically switched through, in the received order, without having to press the answer/extend key. Key lamp shows steady light when automatic answer is activated. See section [“Manual or automatic answer”](#) on page 21.
- 8 Automatic extending**
Automatic extend mode. Calls are automatically extended, after the last entered digit, without having to press the answer/extend key. Key lamp shows steady light when automatic answer is activated. See section [“Manual or automatic extending”](#) on page 22.
- 9 Continuous ring**
Continuous ring mode. Incoming calls are signalled with repeated ring signals. Key lamp shows steady light when continuous ring is activated.

10 Flash

To cause a time break on a connected external line. You can for instance signal a toll operator or other exchanges.

11 Supervision Loop keys

Used to hold individual calls, to Camp On to a busy external line or to assist in paging and conferencing. Key lamp flashes slowly when the feature is activated and fast when a predetermined time for a call put on hold is expired. See section “[To put on hold using Loop keys, Loop 1-4](#)” on page 48.

12 Monitor loop

To monitor a call on hold. Press again to reconnect to the monitored call, e.g. during call set-ups such as: paging, international calls, long distance calls or person to person calls. Key lamp flashes slowly when Monitoring is activated. See section “[To put on hold using the Monitor loop key](#)” on page 48.

13 Speech

To talk to both parties simultaneously. See sections “[Announcing](#)” on page 49, “[Call Metering](#)” on page 53 and “[Assistance](#)” on page 60.

The circumstances for the use of the Speech keys are:

- Manual start of ring signal.
- Implement the Call Splitting and Intrusion features.
- Ring an extension when it is in the reserved state.
- Announce a call to an extension.
- Check the connection to a busy extension.

14 Clear left key / Clear right key**Clear left**

To disconnect the source party and to clear the left side of the display (centre row). Also used to retrieve last extended call or call put on hold.

Clear right

To disconnect the destination party and to clear the right side of the display (centre row). Also used to retrieve last extended call or call put on hold.

15 Speech left key / Speech right key

Speech left

To talk to the source party.

Speech right

To talk to the destination party.

16 Microphone

Not used.

17 Answer/Extend

To answer and extend incoming line calls. The key is also used to start automatic ring signal and to put a call on hold.

18 Headset key

To switch from handset to headset. The key lamp shows steady light when calls are connected to the headset. See section [“Accessories”](#) on page 88.

Note: *Headset is optional.*

19 Announce

To initiate extending with announcement or Camp On to busy extension or external line.

20 Mute

During a call: To switch the microphone on or off.

In idle mode or when ringing: To switch off the ring signal.

21 Volume control

To change the volume.

22 Loudspeaker for ring signal

23 Handset

Supplied with hearing aid function as standard.

Please note: *The handset may attract and retain small metal objects in the earcap region.*

24 Press to talk button

Located in the handset. Used in two ways:

Press and hold: Voice connection with connected party(ies).

Release: Disconnect from connected party(ies).

Note: *The press to talk button can be locked or released by pushing the small button forward or backward.*

25 Pull-out leaf for personal telephone number list (optional)

See section “[Accessories](#)” on page 88.

26 Designation card

Use the DCM (Designation Card Manager) to make and print your own designation cards. DCM is included on the Enterprise Telephone Toolbox CD or it can be downloaded from:

<http://www.aastra.com>

For more information, please contact your Aastra Certified Sales Partner.

Display information

The display codes indicate which function the terminal is currently performing. The display consist of 5x40 characters.

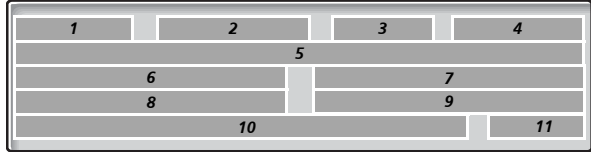

The top row (1-4)

The row shows the following:

1 Queue information

- C = 00 Common operator queue, two digits
- I = 00 Individual operator queue, two digits

2 Type of incoming call

- DIVERTED Diverted call
- EMERGENCY Emergency call (internal)
- INTERNAL Internal call
- PRIVATE TRK Call from a private network line
- PUBLIC TRK Call from a public line
- RECALL Recall call
- REROUTED Rerouted call

3 Activated Metering, paging or Serial call

- METER Metered call
- PAGING Paging call
- SERIAL Serial call

4 Terminal or exchange status

BLOCKED	Terminal is blocked
EXG EMER .	Exchange is in Emergency mode
NIGHT SERV .	Exchange is night switched
OFF DUTY	Terminal is in absent mode

The second row (5)

The row shows the following:

- The source (left side) shows details on the first connection, this is usually an incoming call to be extended by the operator, but also an outgoing call when initiated by the operator.
- The destination (right side) shows details on the second connection. This is usually the extension an incoming call is connected to.

abc	Line identity, TRK is default (changed by your system administrator)
ABSENT	Called party is absent
ANSWER	Call is answered
BLOCKED	Called party or line is blocked
BUSY	Called party is busy
CONFER .	Conference call
CONGEST .	Congestion
C.WAITING	Call Waiting
DATA EXT	Data extension
DTMF-TONE	Dialing-during speech mode
EXTENSION	Voice extension
FREE	Called party is free
FORWARD TO TRUNK	Called party has activated External Follow-me
INCOMING	Incoming call
INTERCEPT	Interception call
ISDN EXT	ISDN terminal
L.LOCKED	Line locked out
LOCAL	Local mode
MEMBER	Member in a conference

NO DIST	Do not disturb
NO RESP	No response
OPERATOR	Operator
OUTGOING	Outgoing external line
RECALL	Recall
RESERVED	Reserved
SPEECH	Speech mode
TEST	Test mode
TRANSFER	Transferred call
TRK	External line
UNAVAIL	Unavailable number
VACANT	Vacant number
WAIT	Wait
<-	The terminal is connected to the left side
->	The terminal is connected to the right side
<-->	The terminal is connected to both sides

The third row (6-7)

The row shows the following:

6 Party identity source side

1-19 digits	Number (extension or operator)
9 digits	External line data (external line)

7 Party identity destination side

1-19 digits	Number (extension or operator)
-------------	--------------------------------

The fourth row (8-9)

The row shows the following:

Note: *The name is shown only if it is received from the calling or called party.*

8 Name identity source side and 9 destination side

1-19 characters Name

The fifth row (10-11)

The row shows the following:

Note: *Name presentation will only be displayed if your exchange is equipped with this function, and if the extension or group has a named assigned.*

10 Dialed number, name and number for diverted extension, metering pulses, absence information, etc.

1-19 characters, 1-10 digits	Name and number for diverted extension
1-19 digits	Dialed number
ACCEPTED	Accepted
C.WAIT PERMIT	Call Waiting is permitted
CONGESTION	Congestion
MISCALL	Missed call. Dialed procedure has a wrong format
REJECTED	Rejected call
RESTRICTED	Restricted

11 System time, alarm class or maintenance status

15:25	System time in 24 hours format
3:25 AM	System time AM in 12 hours format
3:25 PM	System time PM in 12 hours format
ALARM:n	Alarm class, n=2, 3 or 4
EXG SERV	Service is ongoing
NO ALARM	No alarm in log

Preparing the terminal

On/Off duty

The terminal must be turned on to receive calls.

Note: *As an option, calls to the individual operator number can be received even if the terminal is turned off, if required contact your system administrator.*

OFF DUTY appears on the top row of the display if the terminal is turned off.

NIGHT SERV appears on the top row of the display if the terminal is in Night Service mode.

To turn the terminal on or switch it to Day Service:



on/off

Press.

(To turn the terminal off press the key again.)

If an incoming call is not answered within a predetermined time, the terminal is automatically switched off.

Ring signal

The terminal uses different acoustic sounds to signal incoming calls.

- One tone ringer, this signals an internal call to the terminal, used for normal and heavy traffic.
- Two tones ringer, this signals an external call or a recall to the terminal, used for normal and heavy traffic.
- Continuous tone ringer, this signals an emergency call, or a normal call that is not answered within a predetermined time.

Note: *The tone ringer level cannot be altered.*

Normally the terminal signals just once. If you have to move around within hearing distance from the terminal, you can set the terminal in the continuous signal mode:

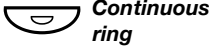

Press.

The key lamp is switched on, signaling that the terminal is in the continuous signal mode.

To return to normal ringing:

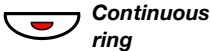

Press.

Manual or automatic answer

The terminal can be used in automatic or manual mode. In automatic mode, calls are answered immediately without pressing a key.

To activate automatic answer:



**Automatic
answer**

Press.

The key lamp is switched on, signaling that calls will be automatically answered.

To return to manual answering:



**Automatic
answer**

Press.

Note: *If the terminal is programmed for automatic answer, you do not need to press the answer/extend key in order to answer calls.*

Manual or automatic extending

Incoming calls can be extended automatically or manually, automatically extended calls are transferred to extensions without pressing a key.

To activate automatic extending:



**Automatic
extending**

Press.

The key lamp is switched on, signaling that calls will be automatically extended.

To return to manual extending:



**Automatic
extending**

Press.

In this user guide the operator features are described with the the terminal programmed for manual extending.

***Note:** If the terminal is programmed for automatic extending, you do not need to press the answer/extend key in order to extend calls.*

Choice of language (optional)

One of the following languages can be chosen to be used for the display information on your terminal.

Digit 0–9 = the language code:

0 English	1 French	2 German	3 Spanish	4 Italian
5 _____	6 _____	7 _____	8 _____	9 _____

***Note:** By default 5-9 are programmed for English. To be changed locally to other languages.*

To choose a new language:

*** 0 8 ***

Dial.

(0 – 4) #

Enter the language code and press.

Handset and headset volume

Use the Volume keys to change the volume of the handset or headset during a call.



Press to change the volume.

The volume level is stored.

For people with impaired hearing, the handset hearing volume level can be extra amplified. To change the level:

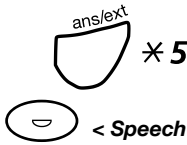

Press simultaneously for at least 1 sec.

A tone signal is heard, and the display shows `Setting Mode`.

Press to set or reset the volume level.

Key lamp on indicates amplified volume level. Key lamp off indicates default volume.

#

Press to finish setting.

When extra amplification has been selected, the Line 1 key lamp turns off.

Note: A level change also effects a headset connected to the headset outlet.

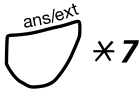

Melody ringing

If you want to replace the ring signal with personal melodies when your phone rings, you can program one melody to signal an internal call, and another melody to signal a Recall call.

Press and hold simultaneously to enter melody mode.



If there is a stored and activated melody for internal calls (< Speech) or Recall calls (Flash), the corresponding key lamp is switched on.

In melody mode you can:

- Program new melodies
- Edit or delete stored melodies
- Activate or deactivate stored melodies

Press to exit melody mode.

Note: *If you do not press any key within 30 seconds, melody mode is automatically cancelled.*

Program a new melody, edit or delete a current melody



Alarm

Press.



Press the key for the requested type of call:

If there is a current melody, the melody is played and the last 19 notes or signs are displayed.



< Speech

Press for internal calls,

or

press for Recall calls.



Flash



To edit the current melody:

Press to move the cursor to the right of the position to be edited.

Keep pressed to go to the beginning or to the end.



Press to erase the note to the left of the cursor.

Keep pressed to erase all the notes.

To enter a new melody or new notes, see section [“To enter notes”](#) on page 27.



< Speech

Press for internal calls,

or

press for Recall calls.



Flash



Alarm

Press.

The current melody is stored.

Note: *The melody is not activated, see section [“Activate or deactivate a stored melody”](#) on page 26.*

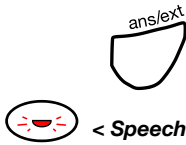

To delete the current melody:

Press and hold until no notes are displayed.

Press for internal calls,

or

press for Recall calls.



Press.

Activate or deactivate a stored melody

A stored melody has to be activated in melody mode to be heard when you get an incoming call.

To activate (in melody mode):

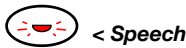

Press for internal calls,

or

press for Recall calls.



The corresponding key lamp is switched on:

< Speech key = Internal calls

Flash key = Recall calls

Note: *If you want to return to an ordinary ring signal but keep the melody stored, just press the key for the requested type of call again. When the key lamp is off the stored melody is deactivated.*

#

Press to exit melody mode.

1c 2d 3e
 4f 5g 6a
 7b 8+c 9+d

To enter notes

In melody mode, the key pad is used to enter notes, pauses, etc. A maximum of 40 notes can be programmed for incoming calls, and 20 notes for recalls.

This is how the keys are used:

Press to insert notes (1–9).

Note: A long press gives a long tone (displayed by a capital letter), +c and +d means the higher octave.

✳

Press to insert a short pause (p).

Hold to get a long pause (P). Repeat to get a longer pause (pp...p).

0

Press to get a higher octave for the inserted note.

A + is shown in front of the note to indicate the higher octave.

Example: 30 to get +e

#

Press to increase or decrease the pitch for the inserted note.

Press once for sharp pitch, twice for flat pitch and three times to get the normal pitch.

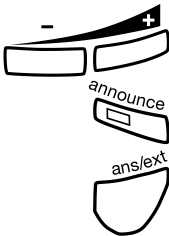

Press to move the cursor to the left or to the right.

Keep pressed to go to the beginning or to the end.

Press to listen to the entered notes.

Press to erase the note to the left of the cursor.

Keep pressed to erase all the notes.

Melody example:

James Bond theme programmed for internal calls:

C d d D D pp C C C C #d #d #D #D pp D D D ##A G pppp G F G

Enter the notes.

Grey digit = Long press.

1 2 2 2 2 ✳ ✳ 1 1 1
 1 2 # 2 # 2 # 2 #
 ✳ ✳ 2 2 2 6 # # 5
 ✳ ✳ ✳ ✳ 5 4 5

Note: The # key (to get a sharp or flat tone) is pressed after the note, but is displayed before the note.

When the first 19 positions are entered, the display shows (only last entered 19 positions can be shown):

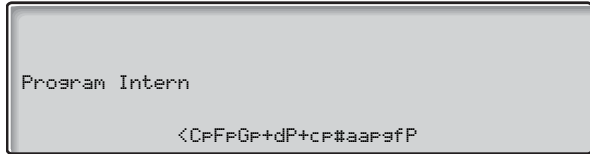

When all the notes are entered, the display shows (only last entered 19 positions are shown):

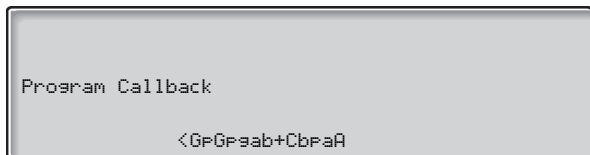

Note: The flat A (##A) is shown as bA, i.e. b is used to show both the note b and the flat sign.

Display contrast

You can adjust the display contrast level.

Press and hold simultaneously until a ring signal is heard.

The display shows **Settings Mode**.

Press.

Press repeatedly to adjust the contrast.

Press to save and exit.

Note: To exit the menu without saving the changes, press **#** before you press any of the adjustment keys.

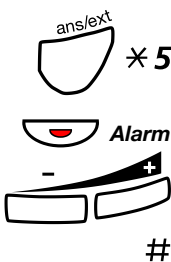

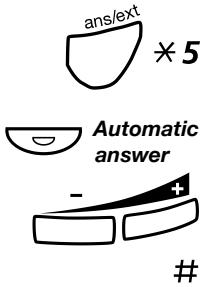

Display backlight

You can adjust the display backlight level.

Press and hold simultaneously until a ring signal is heard.
The display shows `Setting Mode`.

Press.

Press repeatedly to adjust the backlight level.

Press to save and exit.

Note: To exit the menu without saving the changes, press **#** before you press any of the adjustment keys.

Incoming Calls

Normal incoming calls

The terminal rings to signal an incoming call. The display shows the number of calls waiting in the common and personal queues, type of incoming call, the external line data or the number and name of the calling extension.

Display examples:

Incoming external call

```
C= 1 I= 0 PUBLIC TRK
TRK      INCOMING
      010003012
                                     15:25
```

Incoming internal call

```
C= 1 I= 0 INTERNAL
EXTENSION INCOMING
      206
      BOB BURNES
                                     15:25
```



Press to answer the call.

< Speech key lamp is switched on and you are connected to the calling party.

Rerouted calls

If a call fails to reach the designated location it is rerouted to the terminal. The terminal rings and the display shows that the call is rerouted and the reason for rerouting:

Display example:

Dialed extension is busy

```

C= 1 I= 0 INTERNAL
EXTENSION BUSY
      206
      BOB BURNES
                                                    15:25
  
```

BUSY

Dialed extension is busy.

CONGEST .

Resource congestion is encountered.

BLOCKED

Dialed extension is blocked.

VACANT

Dialed number is vacant or the number is incomplete.



Press to answer the call.

< Speech key lamp is switched on and you are connected to the calling party.

Correct if possible, and inform the caller.

An extension calls the terminal

An extension can contact the terminal using one of two methods, dialing a common operator number or dialing an individual operator number.

Display example:

The common operator number (9) is dialed

```
C= 1 I= 0 INTERNAL
EXTENSION INCOMING
      206
      BOB BURNES
                                     9  15:25
```

Notes:

*If the calling party is an ISDN terminal **ISDN EXT** appears on the display in place of **EXTENSION**.*

If the caller has dialed your individual operator number, this number is shown instead of the common number.



Press to answer the call.

< Speech key lamp is switched on and you are connected to the calling party.

An operator calls the terminal

When an operator dials the common operator number, the display shows:

Display example:

The common operator number (9) is dialed.

```
C= 1 I= 0 INTERNAL
OPERATOR INCOMING
      202
MARY WATERS
                                     9  15:25
```

Note: *If the operator has dialed your individual operator number, this number is shown instead of the common number.*



Press to answer the call.

< Speech key lamp is switched on and you are connected to the calling party.

Inquiry

When an extension contacts the operator with an external call put on hold, proceed in the same manner as section [“An extension calls the terminal”](#) on page 32.

To reconnect the extension to the external line:



< **Clear**

Press.

The terminal is cleared.

To connect the terminal to the external call:

Ask the extension to replace the handset.

When the extension replaces the handset you are automatically connected to the caller. The display shows TRK, TRANSFER and the external line data.

Emergency calls

An emergency call from an extension is signalled by a continuous ring signal.

Display example:

Incoming emergency call.

```
C= 1 I= 0 INTERNAL
EMERGENCY INCOMING
      207
      DAVID GILMOUR
                                250  15:25
```

Note: *If the emergency call is from a tie line, the display shows PRIVATE TRK instead.*



Press to answer the call.

< Speech key lamp is switched on and you are connected to the calling party.

Diverted calls

When a caller is diverted to your terminal.

Display example:

Incoming external call to extension 207.

```
C= 1 I= 0 DIVERTED
TRK      FORWARD
      010003012
      DAVID GILMOUR
                                207  15:25
```

Note: *If the call is from an extension, the display shows EXTENSION and the extension's name and number instead.*



Press to answer the call.

< Speech key lamp is switched on and you are connected to the calling party.

Absence information (Message Diversion)

Absence information for an extension can be activated either from the operator terminal or at the telephone. When a called extension has activated an absence information and the call is diverted to the terminal, a single tone is heard.

Display examples:

Diverted external call to extension 206.

```
C= 1 I= 0 PUBLIC TRK
TRK      FORWARD      EXTENSION
          010003012          206
                               BOB BURNES
                               MEETING 1600  15:25
```

Diverted internal call to extension 206.

```
C= 1 I= 0 DOVERTED
EXTENSION FORWARD      EXTENSION
          207          206
          DAVID GILMORE          BOB BURNES
                               MEETING 1600  15:25
```



Press to answer the call.

< Speech key lamp is switched on and you are connected to the calling party.

Give the information to the caller.

Press.

The terminal is cleared.

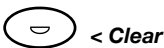

Note: *The activated absence information can be bypassed, see section “[Bypassing](#)” on page 46.*

Extending

This chapter describes how to extend calls to extensions, operators, paging units and external lines.

Free extension

To transfer a call displayed on the left side to an extension.



Dial the extension number.

The right side of the display shows EXTENSION FREE and the called extension's number and name.

Press to extend the call.

The call is extended and the terminal is cleared.

Note: *If the terminal is set to automatic extending mode, the call is automatically extended after the last digit of the extension number is dialed and the terminal is cleared.*

Announce call

If you want to announce the call before extending (the terminal must be in manual extending mode).



Dial the extension number.

The right side of the display shows EXTENSION and the called extension's number and name.

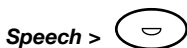

Press.

Speech > key lamp is switched on and the terminal rings the extension.

Note: *If the called extension is in a private network, there is no need to press the Speech > key to call, as it is done automatically.*

When the called party answers, ANSWER is shown.

Announce the call.

Note: *System dependent, the calling party can listen to the announcement.*



Press to extend the call.

The call is extended and the terminal is cleared.

Retrieve a call

It is possible to retrieve an extended call before it has been answered, e.g. if you dialed a wrong number.

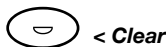

Press.

You can also press the Clear > key. The display shows the data of the extended call.

To correct the number:

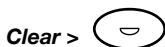

Press.

Proceed to extend the call as normal.

Busy extension

If BUSY is shown the extension is busy, inform the caller and ask if he/she wants to hold or call later.



If the caller wants to hold:

Press to extend the call.

The call is extended and camped on to the busy extension. The terminal is cleared.

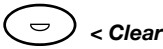

If the caller wants to call later:

Press.

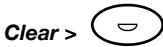

Press.

The call is disconnected and the terminal is cleared.

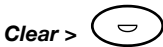

If the caller wants to be connected to another extension:

Press.



Dial the extension number.

Proceed to extend the call as normal.

If the busy extension has a previous call camped on C. WAITING and RESTRICTED are shown:

However, if your system is programmed that way, it might be possible to have several calls camped on to the same extension (1 - 9).

You can put the call on hold, see section "On hold" on page 47.

Barred extension

When an extension is barred from receiving direct indialed calls from the public network, it is rerouted to you.

Display example:

```
C= 1 I= 0 REROUTED
TRK      INTERCEPT<- EXTENSION
          010003012                206
                                   BOB BURNES
          RESTRICTED                15:25
```

Inform the caller that the requested extension is barred for direct dialing.

If the caller wants you to extend the call to the required extension:

Clear >  

Press and dial the extension number.
Extend the call in the usual manner.

If the called party is restricted to receive external calls at all you can pass on a message to the extension:

Clear >  

Press and dial the extension number.
Extension is free.

Speech > 

Press.
The terminal rings the extension. When the extension answers (ANSWER is shown) you can pass on the message.

 **< Speech**

Press.
Inform the calling external party of the reply.

 **< Clear**

To terminate the calls:

Clear > 

Press.
The calls are disconnected and the terminal is cleared.

Vacant number

When a vacant extension number is given to you by the calling party, VACANT is shown.

Inform the caller about the situation.

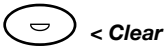

Press.

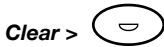

Press.

The calls are disconnected and the terminal is cleared.

Absence information (activated Message Diversion)

When an external party wishes to speak to an extension with an activated absence information.



Dial the extension number.

The terminal shows the absence reason, and if entered, the time/ date of return.

Give the information to the caller.

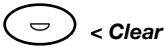

Press.

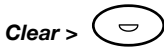

Press.

The calls are disconnected and the terminal is cleared.

Note: *The activated absence information can be bypassed, see section “[Bypassing](#)” on page 46.*

Diverted extension

When you extend a call to a diverted internal extension.



Dial the extension number.

The right side of the display shows the answering position (divertee) and the bottom row shows the dialed number.

Display example:

```
C= 1 I= 0 PUBLIC TRK
TRK      INCOMING      EXTENSION FREE
          010003012          206
                                BOB BURNES
          DAVID GILMOUR          207  15:25
```



Press to extend the call.

The call is extended and the terminal is cleared.

External Follow-me

When you extend a call to an internal extension that has activated an External Follow-me, i.e. ordered a transfer of incoming calls to an external phone number.



Dial the extension number.

The display momentarily shows FORWARD TO TRUNK. The Speech > key is switched on, the right side of the display shows line data, etc., and the bottom row shows the dialed name and number.

Display example:

```
C= 1 I= 0 PUBLIC TRK
TRK      INCOMING      TRK      OUTGOING
          010003012          010002005
          DAVID GILMOUR          207  15:25
```



Press to extend the call.

The call is extended and the terminal is cleared.

Personal Number

When you extend a call to an extension that has activated a Personal Number profile.

Note: At automatic extending, or when you extend before sending a ring signal towards the extension, the terminal gives normal information.

If you want to send a ring signal before extending:



Dial the extension number.

Note: Manual ringing is not possible to use against an extension with a cordless phone, an IP phone, an ISDN terminal or Mobile Extension.

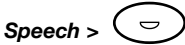

Press to send ring signal.

Display example:

```
C= 1 I= 0 PUBLIC TRK
TRK      INCOMING      EXTENSION FREE
          010003012          206
                              BOB BURNES
          DAVID GILMOUR          207  15:25
```

Note: If the answering position number is the same as the dialed number; the number is shown both as the dialed number and the answering number.



Press to extend the call.

The call is extended and the terminal is cleared.

Operators and groups

To extend a call to another operator or group in your own exchange or private network.

Operators



Dial the extension number.

Display example:

```

C= 1 I= 0 PUBLIC TRK
TRK      INCOMING ->OPERATOR  FREE
          010003012           202
                               MARY WATERS
                               15:25
    
```



Press to extend the call.

The call is extended and the terminal is cleared.

Groups



To extend a call to a group number:

Dial the group number.

The right side of the display shows who is answering and the 5th row shows the group name and number.

Display example:

```

C= 1 I= 0 PUBLIC TRK
TRK      INCOMING  EXTENSION FREE
          010003012           206
                               BOB BURNES
MARKET GROUP           207    15:25
    
```



Press to extend the call.

The call is extended and the terminal is cleared.

Note: *If the whole group is busy the call can still be extended. The call is put on hold and will ring the first extension that becomes free.*

Paging unit

Calls can be extended to a paging unit.



Dial the extension number.

Press to activate the paging facility.

The display shows PAGING on the first row.



Press to extend the call.

The call is extended and the terminal is cleared.

Note: *The paging will start automatically if you extend a call to an extension which has an activated Diversion to a paging unit.*

Normally you will not be involved in the answering procedure. Only if there is no answer you will be recalled after a predetermined time.

If the called person cannot be paged, RESTRICTED is shown.

If the called extension is busy you can Camp On announcing:



Press to activate the paging facility.

The display shows PAGING on the first row.



Press to activate call announcing.



Press to extend the call.

The call is camped on via the paging unit and the terminal is cleared.

Message paging

The paging unit can be equipped to permit message paging. The messages are transmitted as predetermined digit codes containing a maximum of ten digits. The message is shown on the display of the paging receiver.

*** 8 1 ***



Dial.

Dial pagee's extension number and press.



Dial the message code (1-10 digits).

#

Press.

The terminal is cleared.

External line

This could be a call to another exchange within the private network or to the public network.



Dial the code to get a line (for the line you wish to access and the external number).

The display shows TRK. OUTGOING, line data and momentarily the dialed number.



Press to extend the call.

The call is extended and the terminal is cleared.

Bypassing

Diverted extension

When you have called a diverted extension (the right side of the display shows the answering position and the bottom row shows the dialed number).

Clear > 

*** 6 0 ***



#

Speech > 



Press.

Dial.

Dial the extension number.

Press to activate Bypassing.

Press.

If the diverted extension accepts the call:

Press to extend the call.

Absence information

When you have called an extension and receive absence information.

Speech > 

Speech > 



Press.

The extension is called once again but this time there is no absence information.

Press.

If the diverted extension accepts the call:

Press to extend the call.

Service Features

On hold

Putting an ongoing call temporarily on hold leaves the terminal free to perform other actions. The call is time supervised, which means that you are recalled if the call is not retrieved within a certain time period.

The call being put on hold must be in voice connection with the terminal, i.e. either <- or -> must be displayed and the other side of the display must be in idle mode.

To put a call on hold:

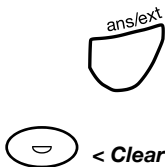

Press to extend the call.

To retrieve the last call put on hold, the terminal must be in idle mode.

Press.

You can also press the Clear > key. The call is retrieved.

Note: *If you have extended calls after a call was put on hold, and any of these calls have not been answered, the last extended call will be retrieved.*

For a retrieved call the display shows RECALL and depending on type of call, EXTENSION or TRK with the relevant number, name or line data.

To put on hold using Loop keys, Loop 1-4

An alternative method to put a call on hold is by using a Loop key.

To put the call on hold:

Loop 2 

Press a free Loop key.

The corresponding Loop key lamp flashes and the terminal is cleared.

To retrieve the call:

Loop 2 

Press the relevant Loop key.

The lamp extinguishes and you have voice connection with the party that was put on hold.

The display shows **RECALL** and depending on type of call, **EXTENSION** or **TRK** with the relevant number, name or line data.

To put on hold using the Monitor loop key

Calls can also be put on hold using the Monitor loop key. This method allows the operator to listen to the party that was put on hold. The call is not time supervised and does not recall.

Note: *The Monitor loop key cannot be applied to a conference call.*

Monitor loop 

Press to put the call on hold.

The lamp lights and flashes slowly.

The terminal is cleared and a one way listening path is established to allow you to monitor the party that is put on hold.

Monitor loop 

Press to retrieve the call on hold.

The display shows **RECALL** and depending on type of call, **EXTENSION** or **TRK** with the relevant number, name or line data.

Announcing

When you receive a call for an extension that needs to be announced before extending follow these procedures (the terminal must be in manual extending mode).

The extension is free



Dial the extension number.

The right side of the display shows EXTENSION and the called extension's number and name.

Speech >



Press.

When the called party answers, ANSWER is shown.

Note: *If the extension called is in your own private network there is no need to press the Speech > key to call as it is done automatically.*

Announce the call.

Note: *If you want to speak to both parties simultaneously, press the < Speech > key before extending.*



Press to extend the call.

The call is extended and the terminal is cleared.

The extension is busy

If you are announcing a call to a busy extension and Call Waiting is permitted.

The display shows BUSY and C.WAIT PERMIT

If the caller wishes to wait:



Press to activate call announcing.



Press to Camp On the call.

The call is camped on to the extension with announcing, the terminal is cleared. When the extension becomes free you will be recalled.

Display example:

```
C= 1 I= 0 RECALL
TRK      RECALL      EXTENSION RESERVED
          010003012      206
                              BOB BURNES
                              15:25
```



Press.

Voice connection with the party that was put on hold.

Speech >



Press.

The terminal rings the extension. When the called party answers, ANSWER is shown.

< Speech >



Announce the call.

Press.

Voice connection with the caller and the extension.



Press to extend the call.

The call is extended and the terminal is cleared.

Recall

A recall is a:

- Call put on hold by the answer/extend key.
- Call put on hold by a Loop key.
- Call extended to a free extension which does not answer.
- Call extended to a busy extension.

The calls are time supervised. When the call is not retrieved or answered within a predetermined time (changeable by the your system administrator), the call will be returned to the terminal.

Calls put on hold by the answer/extend key or by a Loop key

The terminal rings (if put on hold by a Loop key, the corresponding key flashes).

Display example:

```

C= 1 I= 0 RECALL
TRK      RECALL
          010003012
                                     15:25
  
```

If the recall is from an extension, EXTENSION, number and name is shown instead of TRK and line data.

Press to answer the call.



No answer or busy extension

The terminal rings.

Display example:

```
C= 1 I= 0 RECALL
TRK      RECALL      EXTENSION BUSY
          010003012    206
                              BOB BURNES
                              15:25
```



If the recall is from an extension, EXTENSION, number and name is shown instead of TRK and line data. If the called extension is free, FREE is shown instead of BUSY.

Press to answer the call.

If the extension answers:

A warning tone is heard, ANSWER is displayed and you have voice connection with both parties.



Press to extend the call.

The call is extended and the terminal is cleared.

Call Metering

An extension can request an external line with Call Metering. Using the following methods, the operator can provide the requested service:

Note: *The first two alternatives are not possible to use against an extension with a cordless phone, an IP phone, an ISDN terminal or Mobile Extension.*

Calling extension first

This method stops the extension from receiving or making other calls whilst you are preparing the requested metered call.

Ask the extension to hang up.



Dial the extension number.



Press.



Dial the external number.

Ask the called party to hold the line.



< **Speech**

Press and announce the call.

You are reconnected to the extension.

< **Speech** >



Press to talk to both parties.



Press to extend the call.

The call is extended and the terminal is cleared.

Calling external party first



Ask the extension to hang up.

Press.



Make an external call in the usual manner.

Ask the called party to hold the line.

Call the extension.

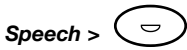

Press.

Announce the call when the extension answers.

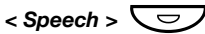

Press to talk to both parties.



Press to extend the call.

The call is extended and the terminal is cleared.

Extension is waiting with the handset off



Press.



Dial the external number.

Inform the called party that you have a caller for them.

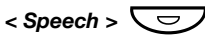

Press to talk to both parties.

Announce the call.



Press to extend the call.

The call is extended and the terminal is cleared.

Dial tone ordering

An extension calls the terminal and requests an external metered line.



Ask the caller to hold the line.

Press.



Dial the code to get an external line.

Dial tone.



Press to extend the call.

The line is extended and the terminal is cleared.

Recall from a metered call

All metered calls are recalled to the operator on completion so the operator can read the meter.

Display example:

```

C= 1 I= 0 RECALL          METER
EXTENSION
      206
      BOB BURNES
                                76   15:25
    
```



Press.

Note the number of pulses and the extension number/name.



Press.

The last display row changes to show the external number.

Note the external number.

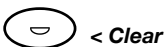

Press.

The call metered is zeroed and the terminal is cleared.

Note: External numbers with a maximum of 20 digits can be read. If you press the meter key once again, the display switches to shows the number of metered pulses again.

Serial calls

A Serial call allows a caller to speak to several extension within the exchange without having to call back. After each conversation is terminated the caller is redirected to the terminal. The operator dials the next extension and extends the next call.

Note: *If you need to be absent marked after a Serial call has been ordered, the function 'Diversion of recall' must be activated, see section "Recalls diverted to another terminal" on page 57.*

When the incoming external call requests a Serial call:

Instruct the caller to hold after each finished conversation.

Press.



Dial the extension number.

Proceed in the same manner as section "Extending" on page 36.

Each time a conversation is finished the caller is recalled to the terminal. Display example:



Press to answer and ask which extension he/she requires next.



Dial the next number and extend.

When the last conversation is completed:

Press to connect to the caller.



Press to cancel the serial call function.

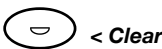

Press.

The call is disconnected and the terminal is cleared.

Recalls diverted to another terminal

If you need to leave the terminal unattended e.g. during a Serial call you must ensure that all calls are redirected to another operator.

To order Diversion of recalls:

*** 2 1 *** 
#

Dial and enter the individual operator number.

Press.

Note: *U.K., dial * 2 * No. #*



Press to activate.

The display shows OFF DUTY on the top row.



To cancel the Diversion of recalls:

Press.

Note: *You can also dial # 2 1 # to cancel the Diversion (U.K.: # 2 #).*

Dialing during a connected call

When calling interactive teleservices, e.g. telephone banks, you need to use Dual Tone Multi Frequency (DTMF) signals. If your exchange is not already programmed to automatically convert your entered digits into DTMF signals, you need to activate the function during the call.

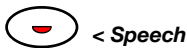

Press during the call.

The display shows DTMF-TONE, informing that you have entered DTMF mode.



Dial the requested digits.

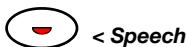

Press to end DTMF mode.

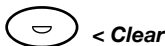

Press to terminate.

The terminal is cleared and the call is disconnected.

Intrusion and Forced release

For urgent calls you can use the Intrusion function to enter busy extensions and, if accepted, disconnect him/her to extend the new call.

An incoming urgent call is connected to the terminal.



Dial the extension number.

The display shows BUSY or CALL WAITING indicating that the extension is busy or busy with a call camped on.

Speech >



Press to intrude on the conversation.

The Intrusion tone is heard and you are connected to the ongoing conversation.

Inform the called party about the urgent call.

If the extension agrees to accept the new call

Speech >



Press.

The required connection is kept, the other extension is disconnected.



Press to connect the call.

The urgent call is connected to the extension, the terminal is cleared.

If the extension wishes to finish the ongoing conversation first



< Speech

Press.

You are connected to the urgent caller.

Inform the caller that you will extend the call as soon as the extension is free.



Press to Camp On the call.

The caller is camped on to the extension and the terminal is cleared.

If the extensions class of service does not permit Intrusion

The bottom row shows RESTRICTED, signaling that Intrusion is not permitted on this extension.

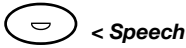

< **Speech**

Press.

You are connected to the urgent caller.

Inform the caller that you are unable to intrude and that they will have to wait until the extension is free.



Press to Camp On the call.

The caller is camped on to the extension and the terminal is cleared.

Call Splitting

When two parties are connected to the terminal (internal or external), Call Splitting allows you to converse privately with either party.

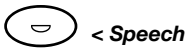

< **Speech**

Press to speak to the left party only.

Voice connection with the left party.

or.

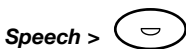

Speech >

Press to speak to the right party only.

Voice connection with the right party.

Assistance

If an extension cannot or is not allowed to perform a task, it can contact an operator to request assistance.

Note: *Depending on the type of exchange, some of the features described in this section may be optional.*

Making calls

Using the following methods, the operator can assist with making calls:

- Calling the extension first
- Calling the external/other party first
- Requesting the extension to wait for the call with the handset off
- Providing a dial tone (Dial tone ordering)

Note: *The first two alternatives cannot be used against an extension with a cordless phone, an IP phone, an ISDN terminal or Mobile Extension.*

Calling the extension first

The extension hangs up after phoning the operator to request assistance. This method of assistance prevents the extension from making or receiving any calls.



Dial the extension number and the requested number.

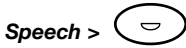

Press (if the requested number is an internal number).

Inform the called party and ask to hold.

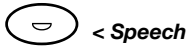

Press.

Announce the call.



Press to extend the call.

The call is extended and the terminal is cleared.

Calling the external/other party first

This allows the extension to initiate or receive calls while the operator contacts the other party.



Dial the number of the other party.

Inform the called party and ask to hold.



Dial the extension number.

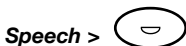

Press.

The terminal rings the extension.

Announce the call when the extension answers.



Press to extend the call.

The call is extended and the terminal is cleared.



Extension is waiting with handset off

Dial the number of the other party.

Ask the called party to hold.

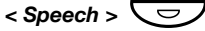

Press to talk to both parties.

Announce the call.



Press to extend the call.

The call is extended and the terminal is cleared.

Dial tone ordering

The calling party requests an external line.

Ask the caller to hold.



Dial the route access code for an external line.

Dial tone.



Press to extend the line.

The line is extended to the extension allowing the caller to make the external call, the terminal is cleared.

Conference calls

A conference call can be established with a maximum of 8 members, you can either lead the Conference or be a member.

Conference leader/initiator

To initiate a Conference (terminal is in idle mode on both sides):

*** 3 #**

Dial.

The display shows CONFER. and FREE.

To add a member to the Conference:



Dial the extension number.

Speech > 

Press.

The terminal rings the extension, inform the extension that a conference call is starting.



Press.

The number of conference members is displayed to the left on the 3rd row.

Repeat the procedure to add more conference members.

To disconnect from an established Conference:

 **< Clear**

Press.

The terminal is cleared.

Note: *When the maximum number of participants is reached, you are automatically disconnected from the Conference.*

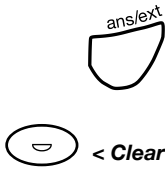

Conference member

An extension can include an operator in a Conference they have initiated.

Note: *As a conference member you do not have access to any operator functions.*

Press.

You are connected to the calling party. The caller informs you that you are connected to a Conference.

Press to terminate.

You are disconnected from the Conference and the terminal is cleared.

Group Hunting

You can help group members to leave and join a group.

To leave the group:

*** 2 1 *** 

Dial and enter the extension number.

#

Press.

Note: *U.K., dial * 2 # No. #*

To re-enter the group:

2 1 * 

Dial and enter the extension number.

#

Press.

Note: *U.K., dial # 2 * No. #*

Programming individual Speed Dialing numbers

You can assist extensions to program Individual Speed Dialing numbers to digit keys 0-9 on the phone key pad. The number to be programmed may consist of a maximum of 20 digits.

Note: *The extension must have access to this function.*

To program or alter a number:

*** 5 1 ***

Dial.

⊙⊙⊙
⊙⊙⊙ *
⊙⊙⊙
⊙

Dial the extension number and press.

(0 – 9) *

Dial selected digit and press.

Note: *Finland, dial (1-9) **

⊙⊙⊙
⊙⊙⊙ #
⊙⊙⊙
⊙

Dial the complete number and press.

To erase a specific number:

5 1 *

Dial.

⊙⊙⊙
⊙⊙⊙ *
⊙⊙⊙
⊙

Dial the extension number and press.

(0 – 9) #

Dial selected digit and press.

Note: *Finland, dial (1-9) #*

To erase all numbers:

5 1 *

Dial.

⊙⊙⊙
⊙⊙⊙ #
⊙⊙⊙
⊙

Dial the extension number and press.

Authorisation code

You can lock/unlock an extension using the individual authorisation code.

To lock an extension:

*** 7 6 ***

Dial.

⦿⦿⦿
⦿⦿⦿ #
⦿
⦿

Dial the extension number and press.

To unlock an extension:

7 6 *

Dial.

⦿⦿⦿
⦿⦿⦿ *
⦿
⦿

Dial the extension number and press.

⦿⦿⦿
⦿⦿⦿ #
⦿
⦿

Dial the individual authorisation code and press.

Contact your system administrator regarding the authorisation code.

Diversion

You can assist an extension to divert calls to a predetermined position specified by your system administrator.

Note: *The extension must have access to this function.*

Direct Diversion when a call is extended to the extension

Activate:

*** 2 1 ***

Dial.

⊙ ⊙ ⊙
⊙ ⊙ ⊙
⊙ ⊙ ⊙
⊙

#

Dial the extension number and press.

Note: *U.K., dial * 2 * No. #*

Cancel:

2 1 *

Dial.

⊙ ⊙ ⊙
⊙ ⊙ ⊙
⊙ ⊙ ⊙
⊙

#

Dial the extension number and press.

Note: *U.K., dial # 2 * No. #*

Diversion when the extension does not answer

Activate:

*** 2 1 1 ***

Dial.

⊙ ⊙ ⊙
⊙ ⊙ ⊙
⊙ ⊙ ⊙
⊙

#

Dial the extension number and press.

Cancel:

2 1 1 *

Dial.

⊙ ⊙ ⊙
⊙ ⊙ ⊙
⊙ ⊙ ⊙
⊙

#

Dial the extension number and press.

Diversion when the extension is busy

Activate:

*** 2 1 2 ***

Dial.

⦿⦿⦿
⦿⦿⦿ #
⦿⦿⦿
⦿

Dial the extension number and press.

Cancel:

2 1 2 *

Dial.

⦿⦿⦿
⦿⦿⦿ #
⦿⦿⦿
⦿

Dial the extension number and press.

Individual Follow-me

Assist an extension to divert calls to an alternative extension number.

Note: *The extension must have access to this function.*

Activate:

*** 2 1 ***

Dial.

⦿⦿⦿
⦿⦿⦿ *
⦿⦿⦿
⦿

Dial the extension number and press.

Note: *U.K., dial * 2 * No. #*

⦿⦿⦿
⦿⦿⦿ #
⦿⦿⦿
⦿

Dial the new number and press.

Cancel:

2 1 *

Dial.

⦿⦿⦿
⦿⦿⦿ #
⦿⦿⦿
⦿

Dial the extension number and press.

Note: *U.K., dial # 2 * No. #*

External Follow-me

You can assist an extension to divert calls to an external number.

Note: *The extension must have access to this function.*

Activate:

*** 2 2 ***

Dial.

⊙ ⊙ ⊙
⊙ ⊙ ⊙
⊙ ⊙ ⊙
⊙

#

Dial the extension number and press.

⊙ ⊙ ⊙
⊙ ⊙ ⊙
⊙ ⊙ ⊙
⊙

#

Dial the code to get a line/external number and press.

Cancel:

2 2 *

Dial.

⊙ ⊙ ⊙
⊙ ⊙ ⊙
⊙ ⊙ ⊙
⊙

#

Dial the extension number and press.

Follow-me to paging unit

You can assist an extension to divert calls to a paging unit.

Activate:

*** 2 1 8 ***

Dial.

⊙ ⊙ ⊙
⊙ ⊙ ⊙
⊙ ⊙ ⊙
⊙

#

Dial the extension number and press.

Cancel:

2 1 8 *

Dial.

⊙ ⊙ ⊙
⊙ ⊙ ⊙
⊙ ⊙ ⊙
⊙

#

Dial the extension number and press.

Absence information (Message Diversion)

You can assist an extension to divert calls into an absence message. The Diversion reason is a predefined one digit code. Time of return is written as four digits, HHMM (time of day) MMDD (Date).

Activate:

230

Dial.

○○○
○○○
○○○
○*

Dial the extension number and press.

(0-9)*

Enter the reason code and press.

Contact your system administrator regarding the valid reason codes.

○○○
○○○
○○○
○#

Dial time or date (HHMM or MMDD) of return and press.

Note: The order in which the date is stated is system dependent.

If no time or date is required:

230

Dial.

○○○
○○○
○○○
○*

Dial the extension number and press.

(0-9)#

Enter the reason code and press.

Contact your system administrator regarding the valid reason codes.

Cancel:

#230*

Dial.

○○○
○○○
○○○
○#

Dial the extension number and press.

Data traffic

Call to a data extension that is free:

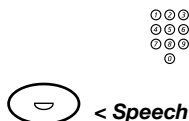

Dial the data extension number.

Press to call the extension.

When the called party answers:



Dial the data extension number again.

The display shows DATA EXT (and FREE if the extension is free).

Press to extend the call.

The call is extended and the terminal is cleared.

If the data extension is in test mode:

The display shows DATA EXT and TEST, informing you that it is not possible to make a connection.

If the data extension is in local mode:

The display shows DATA EXT and LOCAL, informing that it is not possible to make a connection.

If you cannot make a connection:

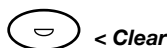

Press to clear the terminal.

Personal Number

As an operator, you can activate, change or deactivate this function for a selected extension.

When an extension has activated a Personal Number search profile, incoming calls are transferred to internal or external phones or back-up services (i.e. voice mail or operator) in the decided order to find the called person.

Depending on the functionality of your exchange, the extension can have either one individual search profile or choose between five individual search profiles.

The search profiles are programmed or modified by your system administrator.

Activate:

*** 1 0 ***

Dial.

⊙⊙⊙
⊙⊙⊙ *
⊙⊙⊙
⊙

Dial the extension number and press.

If a special search profile is required:

(1 – 5)

Press the search profile digit.

Note: *If a search profile digit is not entered, the default list is activated.*

#

Press.

Personal Number is activated.

Cancel:

1 0 *

Dial.

⊙⊙⊙
⊙⊙⊙ #
⊙⊙⊙
⊙

Dial the extension number and press.

Personal Number is deactivated.

Free Seating

You can assist a user with the log off procedure. (The log on procedure must be done by the user from the phone to be used.)

To log off:

1 1 *

Dial.

⊙⊙⊙
⊙⊙⊙
⊙⊙⊙
⊙

#

Dial the extension number and press.

The user is logged off from the used phone.

General Deactivation

You can cancel the following facilities on behalf of an extension by dialing a General Deactivation command:

- Callback
- Diversion direct
- Diversion when the extension is busy
- Diversion when the extension does not answer
- Do not disturb
- Flexible Night Service
- Follow-me (internal, external)
- Manual Message Waiting
- Absence information (Message Diversion)

0 0 1 *

Dial.

⊙⊙⊙
⊙⊙⊙
⊙⊙⊙
⊙

#

Dial the extension number and press.

The General Deactivation is done.

Outgoing Calls

Via any external line

Note: *The terminal must be in idle mode with no party on the left side of the display.*



Dial the code to get an external line and the number.

Display example:

```
C= 1 I= 0
TRK      OUTGOING
        010003012
                                0084220000    15:25
```

To terminate the conversation:

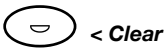

< **Clear**

Press.

The call is disconnected and the terminal is cleared.



If all lines are busy, CONGEST . is displayed, you can start supervision and be recalled when the line becomes free:

Press.

Press.

The route is supervised and the terminal is cleared. The terminal rings when the line becomes free, and the display shows RECALL, TRK and OUTGOING.

Press to answer.

Dial the external number.

If urgent and all external lines are busy you can select a specific external line and use the force release function, see section “Via a specific external line” on page 75.

Via a specific external line



< Clear

Dial.

Dial the line number and press.

Dial the code to get an external line and the external number.

Press to terminate the conversation.

The call is disconnected and the terminal is cleared.

If the line is busy you can start supervision and be recalled when the line becomes free:



Press.

Press.

The line is supervised and the terminal is cleared. The terminal rings when the line becomes free, and the display shows RECALL, TRK and OUTGOING.

Press to answer.

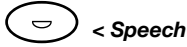

< **Speech**

If you need to make an urgent call and all lines are busy you can intrude and force release a line:

Press to intrude.

Inform the parties on the line about the situation.



< **Speech**

Press to force release.

The call is disconnected and the terminal is cleared.

Start dialing again, use either 'Via any line' or 'Via a specific line'.

Via an ISDN line or via a direct line to another exchange within the private network



Dial the code for the ISDN external line or for the direct line.



Dial the external number.

The dialed number is shown temporarily, then the display shows (example):

```

C= 1 I= 0
TRK      OUTGOING <-
          010003012
                                     15:25

```



< **Clear**

Press to terminate the conversation.

The call is disconnected and the terminal is cleared.

Note: *If all lines are busy CONGEST . is shown.*

To an extension in the private network



Dial the extension number.

The dialed number is shown temporarily, then the display shows (example):

```

C= 1 I= 0
TRK      OUTGOING <-
          206
          BOB BURNES
                                     15:25
    
```



< **Clear**

Press to terminate the conversation.

The call is disconnected and the terminal is cleared.

Note: *If all lines are busy CONGEST . is shown.*

To an extension in your own exchange

Normal call:



Dial the extension number.

Display example:

```

C= 1 I= 0
EXTENSION FREE
          206
          BOB BURNES
                                     15:25
    
```



< **Speech**

Press.

The terminal rings the extension and ANSWER is displayed when the extension answers.



< **Clear**

Press to terminate the conversation.

The call is disconnected and the terminal is cleared.

If the called extension has activated an absence information:

You will see the activated information, see section "[Absence information \(Message Diversion\)](#)" on page 70. You can bypass the information, see section "[Bypassing](#)" on page 46.

If the called extension is diverted:

Display example:

```
C= 1 I= 0
EXTENSION FREE
      207
      DAVID GILMOUR
      BOB BURNES                206  15:25
```

You can bypass the Diversion, see section "[Bypassing](#)" on page 46.

If the called extension has External Follow-me:

FWD TO TRUNK is displayed momentarily, then the display shows (example):

```
C= 1 I= 0
TRK      OUTGOING <-
      010003012
      BOB BURNES 206        15:25
```

If the extension is busy (BUSY is displayed), or a cordless, or an IP extension is unavailable (UNAVAIL is displayed), you can supervise the line until the extension becomes free:

Note: A free extension that does not answer a call can also be supervised.

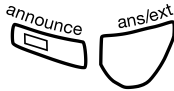

Press.

The extension is camped on. The terminal is cleared and the extension cannot initiate new calls. The terminal rings when the extension becomes free.

Display example:

```
C= 1 I= 0 RECALL
EXTENSION RECALL
      206
      BOB BURNES
                                     15:25
```

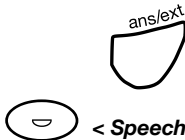

Press to answer the call.

RESERVED is displayed.

Press to call the extension.

The terminal rings the extension and ANSWER is displayed when the extension answers.

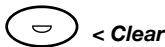

Press to terminate the call.

The call is disconnected and the terminal is cleared.

If the extension is in line locked out state:

The display shows EXTENSION L.LOCKED.

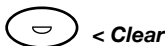

Press to clear the terminal.

Note: When EXTENSION L.LOCKED appears on the display you must clear the terminal and inform maintenance personnel so an investigation can be launched.

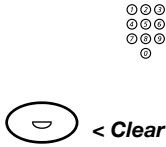

To another operator

Dial the individual operator number.

OPERATOR FREE and the individual operator number and name are displayed. ANSWER is displayed when the operator has answered.

Press to terminate the conversation.

The call is disconnected and the terminal is cleared.

To paging unit

Persons equipped with a wireless paging receiver, can be paged from your terminal. Depending on the type of paging system it is possible to send digit messages or voice messages to the paged person. If you receive a congestion tone when paging, this indicates that the paged person has his paging receiver in the charging rack and is probably out of the office.

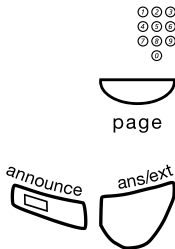

Dial the extension number of the person you want to page.

Press to activate the paging facility.

The paging starts.

Press.

You will be recalled when the person answers.

Answer the recall in the normal way.

Note: *If the paged person does not answer within a certain time, you will not be recalled.*

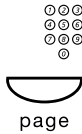

Paging receivers with voice message:

Dial the extension number of the person you want to page.

Press to activate the paging facility.

The paging starts. The display shows PAGING on the first row.

Leave your message after the tone.

Just before the predetermined speech time is ended, a warning tone will be heard.

Note: *The voice channel can be a one way or both way connection.*

You can also send a digit message code, see section "Paging unit" on page 44.

Alarm paging without message code:

*** 8 1 0 ***



Dial.

Dial pagee's extension number and press.

Alarm paging with message code:

*** 8 1 0 ***



Dial.

Dial pagee's extension number and press.



Dial the message code (1-10 digits).

#

Press.

Note: *The alarm paging continues until it is answered.*

Last External Number Redial

To redial the last external number called from the terminal:

*** * ***

Dial.

Note: *Sweden and Finland, dial * * 0*

Speed Dialing

Common Speed Dialing number

These numbers are the same for all users and are programmed centrally from the maintenance terminal.



Dial the common Speed Dialing number and proceed as a normal dialed call.

Individual Speed Dialing number

You can program up to 10 individual Speed Dialing numbers for your own use by using the digit keys 0-9 on the phone key pad. The programmed numbers can consist of a maximum of 20 digits.

Note: *The terminal must have access privileges to this function.*

*** * (0 - 9)**

Press and dial the selected digit and proceed as a normal dialed call.

Note: *Finland, dial * *(1-9)*

To program or alter an Individual Speed Dialing number:

*** 5 1 ***

Dial.

(0 - 9) *

Dial selected digit and press.

Note: *Finland, dial (1-9) **



Dial the complete number and press.

To erase a specific number:

5 1 *

Dial.

(0 - 9) #

Dial selected digit and press.

Note: *Finland, dial (1-9) #*

To erase all numbers:

5 1

Dial.

Other Useful Features

Clock

The time of day is shown in the bottom right hand corner of the display.

AM, PM is only shown if the exchange is programmed in 12 hour format.

Night Service

The exchange has four different types of Night Service:

Common Night Service

All incoming calls are rerouted to a predetermined extension(s).

Individual Night Service

Incoming calls on a particular external line or a group of external lines are rerouted to a predetermined extension or customer.

Universal Night Service

Incoming calls are signalled on several bells situated at different locations in the building. Any extension can answer the calls by lifting the handset and dialing a predetermined answer code.

Flexible Night Service

You can assist in assigning an external line to an extension for use temporarily.

To order flexible Night Service:

✱ 84 ✱

⊙⊙⊙
⊙⊙⊙ ✱
⊙

Dial.

Dial the extension number and press.

⊙⊙⊙ ✱
⊙⊙⊙
⊙

Dial the code to get an external line and press.

⊙⊙⊙ #
⊙⊙⊙
⊙

Dial the external line number and press.

To cancel flexible Night Service:

84 ✱

⊙⊙⊙
⊙⊙⊙ #
⊙

Dial.

Dial the extension number and press.

Note: *If Night Service has lasted more than one hour and has not manually been cancelled by you, the Flexible Night Service will be automatically cancelled one hour after the exchange has been switched back to Day Service.*

Alarm

If a fault occurs in the exchange, the alarm lamp flashes.

Use the following procedure to acknowledge the alarm:



Alarm

Press and hold while reading the display.

The bottom right hand corner of the display shows 2, 3 or 4. The number indicates the degree of seriousness:

2 = Requires action within one week

3 = Requires immediate action during normal working hours

4 = Demands immediate action at all times

The purpose with the acknowledgement of the alarm is to avoid other operators from reporting the alarm. After acknowledgement, you must report the alarm to maintenance, stating the alarm class as above.

When the Alarm key is released, the key lamp changes to steady light. This indicator remains until maintenance staff have eliminated the fault and erased the alarm from the maintenance terminal.

If you press the Alarm key while the lamp shows steady light, EXG SERU is displayed in the bottom right corner indicating that the exchange is being repaired.

Emergency mode

It is possible to set the exchange into Emergency mode. This only allows predetermined extensions to initiate calls.

To set the exchange into Emergency mode:

***90#**

Dial.

EXG EMER is shown in the upper right corner of the display.

To return the exchange to normal state:

#90#

Dial.

Malicious Call Tracing

If you are disturbed by bothersome or malicious external incoming calls you can invoke the Malicious Call Tracing service which will cause an alarm and printout. The printout will contain the calling number, the dialed number, date and time. This information can then be used to determine the origin of the malicious calls.

Note: *The incoming route must have a category for MCT. The feature is supported by the interworking public exchange.*

To invoke the Malicious Call Tracing service:

✖ 3 9 #

Dial.

Busy verification

If a specific extension or external line has been busy for an unusually long time, you can verify its status.

Note: *The right side of the terminal must be in idle mode.*

⓪⓪⓪
⓪⓪⓪
⓪⓪⓪
⓪

Dial the extension number.

or.

⓪⓪⓪
⓪⓪⓪
⓪⓪⓪
⓪

Access a specific external line.

Speech > 

Press.

The right side of the display shows who is connected to the busy extension or external line.

Fault location

There may be situations when there are problems with a specific external line or other interference to equipment failure. There are two ways to verify faulty external lines:

If static or other interference is noticed while connected to an external party, make note of the route number, line module numbers and the external line number.

If all external lines are busy more frequently than seems reasonable, or there is any reason to suspect a problem in a specific external line, each one may be checked, individually, using the procedure described in section "[Via a specific external line](#)" on page 75.

When reporting the fault, consider the following

- Location
- Route number, line module numbers and external line number
- Person reporting the trouble
- Date and time reported
- Person correcting the problem
- Date and time corrected
- Fault reported
- Fault found

Accessories

Headset (optional)

How to install the headset, see section “[Installation](#)” on page 90.



To switch from handset to headset

Press.

The Headset key lamp is turned on.



Replace the handset.



To switch from headset to handset

Lift the handset.



To use the handset for listening to an ongoing call

Lift the handset.



Press.

The Headset key lamp is turned on.

To finish listening:



Replace the handset.

Pull-out leaf (optional)

The pull-out leaf is used for a personal telephone number list and is installed under the terminal. How to install the pull-out leaf, see section “[Installation](#)” on page 90.

Use the DCM (Designation Card Manager) to make and print your own designation cards. DCM is included on the Enterprise Telephone Toolbox CD or it can be downloaded from: <http://www.aastra.com>

For more information, please contact your Aastra Certified Sales Partner.

Option unit (optional)

The option unit DBY 420 01/1 is an optional accessory to be installed under your terminal. The unit is used to connect an extra bell outside your room.

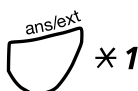

To check or set the option unit for extra bell

Press and hold simultaneously until a ring signal is heard.

The display shows OPTION PROGRAMMING and the Clear > key lamp indicates the setting of the option unit:

- Off=Extra bell.
- (On=Busy signal lamp and Flashing=Combined extra bell & busy lamp). Cannot be used for your terminal.

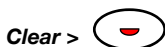

Press twice to change to extra bell.

Note: If the Clear > key is flashing, press the key once to change to extra bell.

#

Press to save the setting and exit.

Note: If you do not press #, the phone automatically returns to idle about 30 seconds after the last key press.

Installation

Install cables

Handset cable to the left

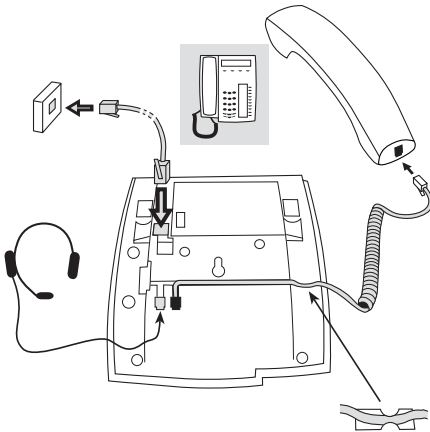

Handset cable to the right

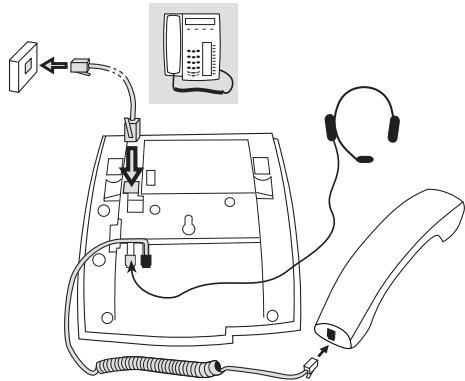

You can put the cable to the handset in the notch underneath the terminal. The cable to the exchange has to be plugged in “LINE” and the handset cable has to be plugged in “HANDSET”.

Change cables

To remove a cable, use a screwdriver to unlock the stop.

Install stands and adapt terminal

Position high

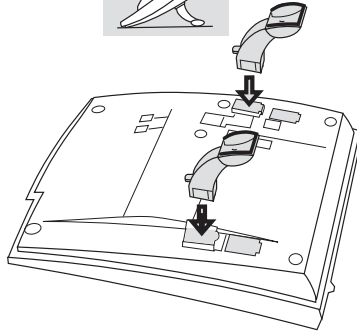

Position low

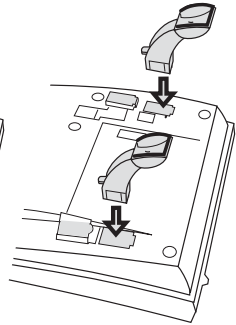

Press to fasten stand

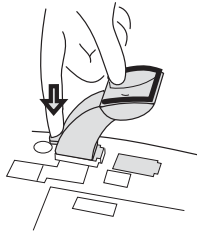

Release to remove stand

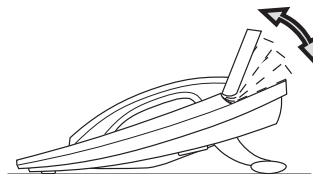
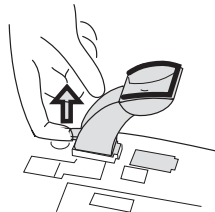

Tiltable display

Adjustable angle

Install card

Use the DCM (Designation Card Manager) to make and print your own designation cards. DCM is included on the Enterprise Telephone Toolbox CD or it can be downloaded from: <http://www.aastra.com>

For more information, please contact your Aastra Certified Sales Partner.

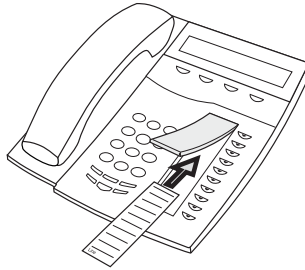

Install pull-out leaf (optional)

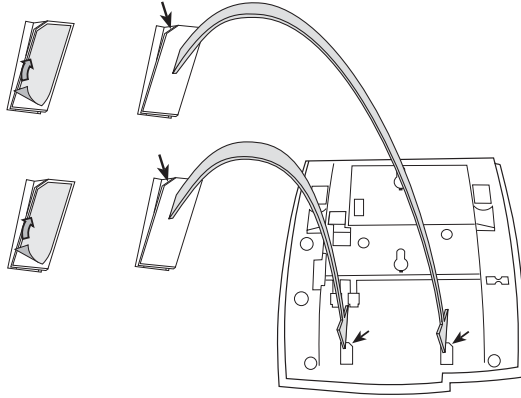

- 1 Remove the protective film from the guiding rails.**
- 2 Attach the guiding rails to the bottom of the terminal, observing the direction of the “cut” corner.**

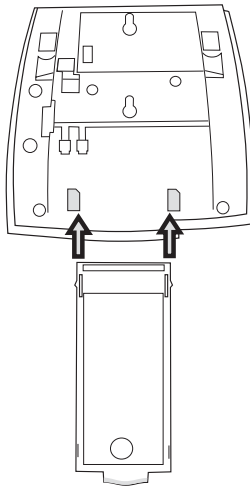

- 3 Insert the pull-out leaf.**

Placing the terminal

Do not expose your terminal to direct sunlight for long periods. Keep the terminal away from excessive heat and moisture.

Cleaning

Clean your terminal only with a soft, water dampened cloth. Using soap or any other cleaning materials may discolor or damage the terminal.

Troubleshooting

When something does not work properly, you can initiate a selftest to check if your terminal is in order, or if the fault is in the system. You can also check the firmware revision state of your terminal.

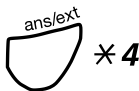

To initiate a selftest

Press and hold simultaneously until a ring signal is heard.

The display shows the firmware revision state and `Selftest OK` for a few seconds. If there is something wrong, a fault message appears. Inform your system administrator about the fault message.

All the key lamps on the phone (and connected extra key panel) should be switched on during the selftest to indicate that each key lamp is OK.

After a few seconds the display is checked (the display is completely dark). The display is OK when there are no light dot(s) or line(s). The light frame around the display is supposed to be there.

#

Press to exit.

Note: *If you do not press #, the selftest is automatically finished after about 30 seconds.*

Glossary

<i>Camp On</i>	To place (queue) a call to a busy extension.
<i>Exchange</i>	Switch. Your telephone system.
<i>Idle mode</i>	The state your phone is in when nothing is activated; not calling, not ringing, not diverted etc.
<i>IP extension</i>	An extension that is using the internal data network (LAN or WAN).
<i>ISDN</i>	Integrated Services Digital Network. Provides your system with supplementary services from the public net.
<i>Speed Dialing number</i>	Abbreviated number or short number, used for making frequently used numbers faster to dial.
<i>Tie line</i>	An external line from the private network.
<i>Trunk line</i>	A trunk line is the same as an external line. Can be either digital or analog.

Index

A

- Accessories 88
 - Headset 88
 - Option unit 89
 - Pull-out leaf 89
- Alarm 85
- Announce call before extending 37
- Announcing 49
- Assistance 60
 - Absence information (Message Diversion) 70
 - Authorisation code 66
 - Conference calls 63
 - Data traffic 71
 - Diversion 67
 - External Follow-me 69
 - Follow-me to paging unit 69
 - Free Seating 73
 - General Deactivation 73
 - Group Hunting 64
 - Individual Follow-me 68
 - Making calls 60
 - Personal Number 72
 - Programming individual Speed Dialing numbers 65
- Authorisation code 66

B

- Barred extension 39
- Busy extension 38
- Busy verification 86
- Bypassing 46
- Bypassing absence information 46
- Bypassing diverted extension 46

C

- Call Metering 53
- Call Splitting 59
- Choice of language 22

- Clock 83
- Common Speed Dialing numbers 82
- Conference calls 63
- Copyright 5

D

- Data traffic 71
- Declaration of conformity 5
- Description 8
 - Display information 14
 - The terminal 8
- Dial tone ordering 55
- Dialing during a connected call 57
- Display information 14
- Disposal of the product 6
- Diversion 67
- Diverted calls 34
- Diverted extension 41
- DTMF signals 57

E

- Emergency calls 34
- Emergency mode 85
- Extending 36
 - Absence information 40
 - Announce call 37
 - Barred extension 39
 - Busy extension 38
 - Bypassing 46
 - Diverted extension 41
 - External Follow-me 71
 - External line 45
 - Free extension 36
 - Message paging 45
 - Operators and groups 43
 - Paging unit 44
 - Personal Number 42
 - Retrieve a call 37
 - Vacant number 40

F

Fault location 87
Follow-me to paging unit 69
Free extension 36
Free Seating 73

G

General Deactivation 73
Glossary 96
Group Hunting 64

H

Handset and headset volume 23
Headset 88
Hold 47

I

Important user information 6
Incoming calls 30

- Absence information 35
- An extension calls the terminal 32
- An operator calls the terminal 33
- Diverted call 34
- Emergency call 34
- Inquiry 33
- Normal incoming call 30
- Rerouted call 31

Individual Follow-me 68
Individual Speed Dialing numbers 82
Inquiry 33
Installation 90
Intrusion and Forced release 58

L

Language 22
Last External Number Redial 81
Lock an extension 66

M

Making calls 60
Malicious Call Tracing 86
Manual or automatic answer 21
Manual or automatic extending 22
Melody ringing 24
Message paging 45

N

Night Service 84

O

On hold 47
On/Off duty 19
Option unit 89
Other useful features 83
Outgoing calls 74

- Last External Number Redial 81
- Speed Dialing 82
 - To an extension in the private network 77
 - To an extension in your own exchange 77
 - To another operator 80
 - To paging unit 80
- Via a specific external line 75
- Via an ISDN line or via a direct line to another exchange within the private network 76
- Via any external line 74

P

Personal Number 42
Preparing the terminal 19

- Choice of language 22
- Manual or automatic answer 21
- Manual or automatic extending 22
- On/Off duty 19
- Ring signal 20

Programming individual Speed Dialing numbers 65
Pull-out leaf 89

R

Recall 51
Recall from a metered call 55
Recalls diverted to another terminal 57
Redial 81
Rerouted calls 31
Retrieve a call 37
Ring signal 20

S

Safety instructions 6
Serial calls 56
Service features 47
Settings

- Handset and headset volume 23
- Melody ringing 24

Short numbers 82
Speed Dialing 82

T

The terminal 8
Troubleshooting 95

U

Unlock an extension 66

V

Vacant number 40
Volume 23

W

Warranty 5
Welcome 4

Subject to alteration without prior notice.
For questions regarding the product,
please contact your Aastra Certified Sales Partner.
Also visit us on <http://www.aastra.com>

© Aastra Telecom Sweden AB 2008 All rights reserved.
EN/LZT 103 63 R4A